

SCHNITT B-B

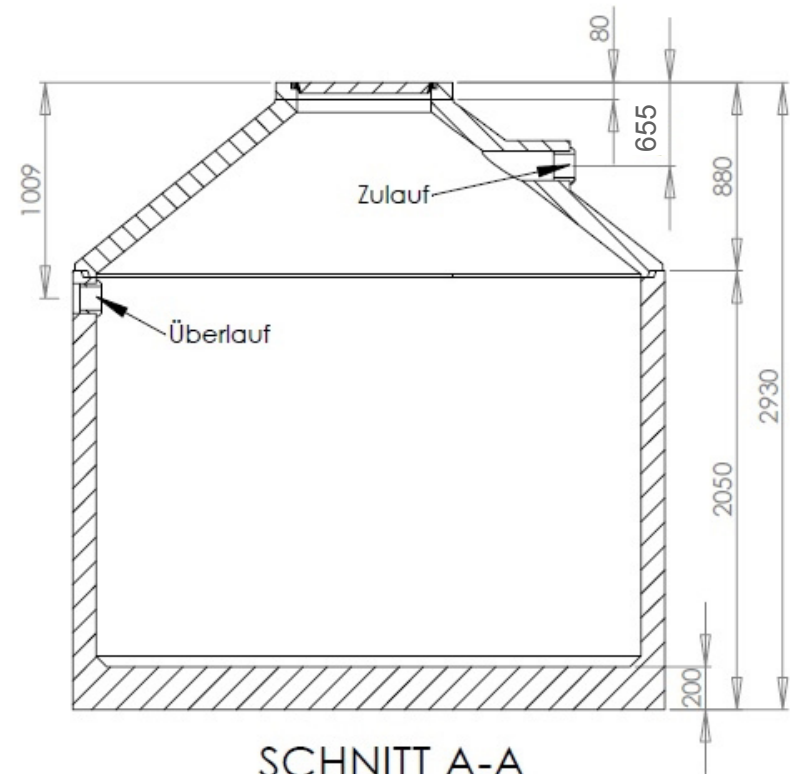

SCHNITT A-A

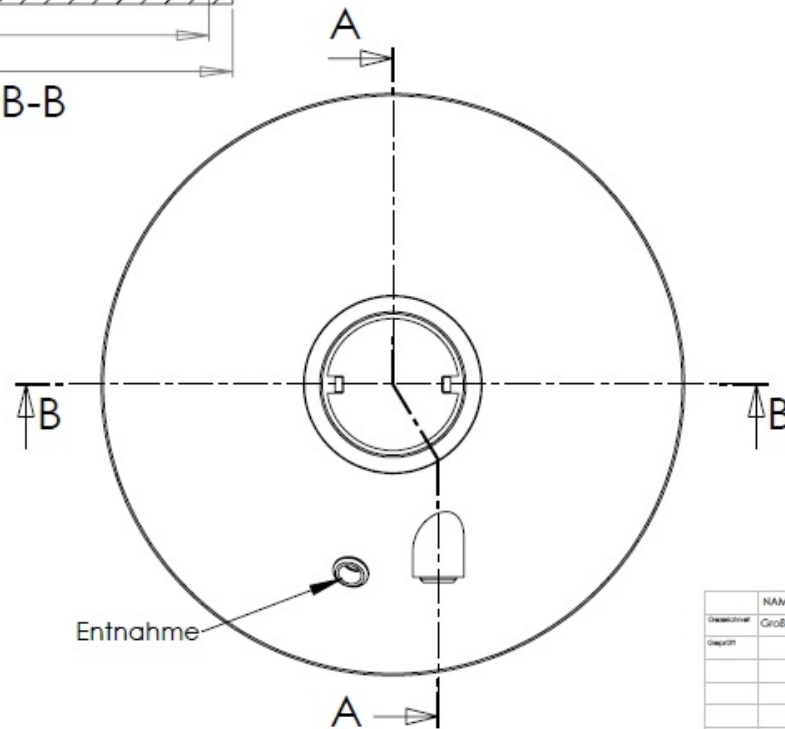

NAME	UNTERSCHRIFT	DATUM	MENGE
Gezeichnet Groß		19.11.2009	
Geprüft			



RZM921H1L